













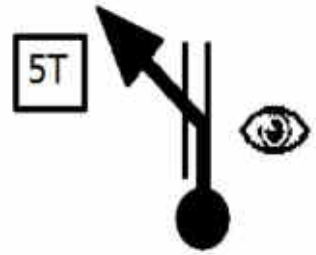

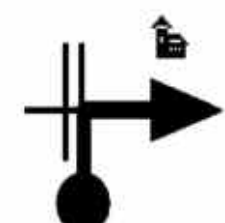

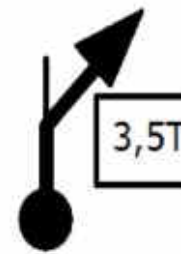
<p>D6</p>	<p>Ingwiller 3</p>	<p>Neuwiller</p>	<p>S.R.P</p> <p>Oberholtz</p>	<p>D233</p> <p>Neuwiller Saverne</p>	
+ 0.2 WP 15 TOT 14.8	+ 1.1 WP 16 TOT 15.9	+ 1.1 WP 17 TOT 17.0	+ 1.4 WP 18 TOT 18.4	+ 3.1 WP 19 TOT 21.5	+ 0.1 WP 20 TOT 21.6
	<p>D14</p>	<p>Petite Pierre</p>	<p>Petite Pierre</p>	<p>Petite Pierre</p>	<p>Weiterswiller</p> <p>WP 35 WP 44</p>
+ 0.1 WP 21 TOT 21.7	+ 0.1 WP 22 TOT 21.8	+ 0.5 WP 23 TOT 22.3	+ 1.8 WP 24 TOT 24.1	+ 5.4 WP 25 TOT 29.5	+ 0.8 WP 26 TOT 30.3
<p>Sparsbach</p>	<p>S.R.P</p> <p>Sparsbach</p>	<p>D656-Ingwiller</p>	<p>D919-Wimmenau</p> <p>Les 4 Vents</p>	<p>S.R.P</p> <p>Wimmenau</p>	
+ 2.4 WP 27 TOT 32.7	+ 4.0 WP 28 TOT 36.7	+ 3.5 WP 29 TOT 40.2	+ 1.2 WP 30 TOT 41.4	+ 5.3 WP 31 TOT 46.7	+ 0.4 WP 32 TOT 47.1

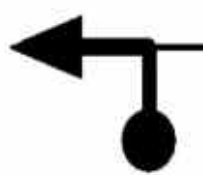
+ 3.2 WP 33 TOT 50.3	+ 2.1 WP 34 TOT 52.4	+ 2.8 WP 35 TOT 55.2	+ 0.3 WP 36 TOT 55.5	+ 2.4 WP 37 TOT 57.9	+ 2.8 WP 38 TOT 60.7

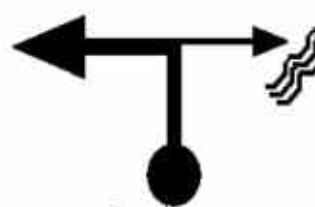
+ 0.6 WP 39 TOT 61.3	+ 0.7 WP 40 TOT 62.0	+ 4.3 WP 41 TOT 66.3	+ 4.0 WP 42 TOT 70.3	+ 0.2 WP 43 TOT 70.5	+ 6.6 WP 44 TOT 77.1

+ 5.4 WP 45 TOT 82.5	+ 1.1 WP 46 TOT 83.6	+ 2.0 WP 47 TOT 85.6	+ 1.1 WP 48 TOT 86.7	+ 1.1 WP 49 TOT 87.8	+ 1.6 WP 50 TOT 89.4

<p>D161d-Berling</p>  <p>Hangviller</p>	<p>D161f-Phalsbourg</p>  <p>Berling</p>	<p>Vescheim</p> 	<p>N61 D38j</p>  <p>Vescheim</p>		<p>N61-Phalsbourg</p>  <p>Zilling</p>
<p>+ 1.5 WP 51 TOT 90.9</p>	<p>+ 1.0 WP 52 TOT 91.9</p>	<p>+ 0.4 WP 53 TOT 92.3</p>	<p>+ 0.8 WP 54 TOT 93.1</p>	<p>+ 0.2 WP 55 TOT 93.3</p>	<p>+ 2.5 WP 56 TOT 95.8</p>
<p>D38-Phalsbourg</p> 	 <p>Mittelbronn</p>		<p>D38k</p> 		 <p>Waltembourg</p>
<p>+ 0.9 WP 57 TOT 96.7</p>	<p>+ 0.9 WP 58 TOT 97.6</p>	<p>+ 0.3 WP 59 TOT 97.9</p>	<p>+ 0.2 WP 60 TOT 98.1</p>	<p>+ 0.7 WP 61 TOT 98.8</p>	<p>+ 2.5 WP 62 TOT 101.3</p>
	<p>D98</p>  <p>Arzviller</p>	<p>Lutzelbourg</p> <p>Plan incliné</p>  <p>Garrebouurg</p>	<p>D98a</p>  <p>Lutzelbourg</p>	 <p>Hultehouse</p>	
<p>+ 0.2 WP 63 TOT 101.5</p>	<p>+ 3.9 WP 64 TOT 105.4</p>	<p>+ 4.4 WP 65 TOT 109.8</p>	<p>+ 2.9 WP 66 TOT 112.7</p>	<p>+ 2.7 WP 67 TOT 115.4</p>	<p>+ 0.0 WP 68 TOT 115.4</p>

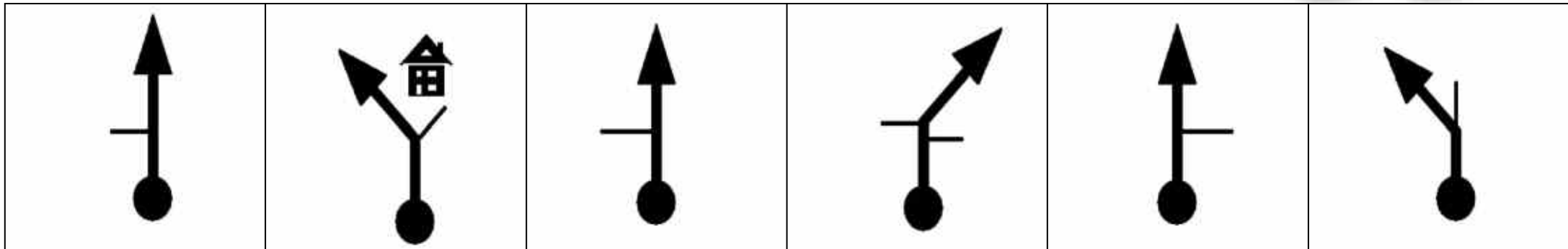

+ 0.3	WP 69	TOT 115.7	+ 0.2	WP 70	TOT 115.9	+ 0.5	WP 71	TOT 116.4	+ 0.2	WP 72	TOT 116.6	+ 0.7	WP 73	TOT 117.3	+ 2.0	WP 74	TOT 119.3
-------	-------	-----------	-------	-------	-----------	-------	-------	-----------	-------	-------	-----------	-------	-------	-----------	-------	-------	-----------

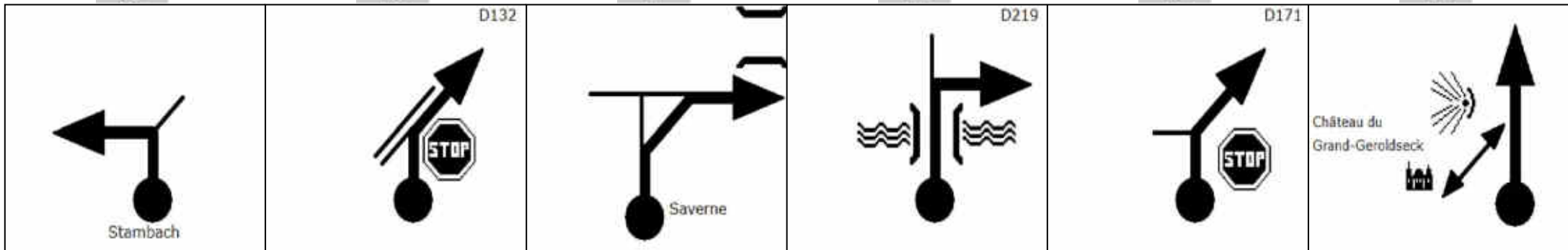



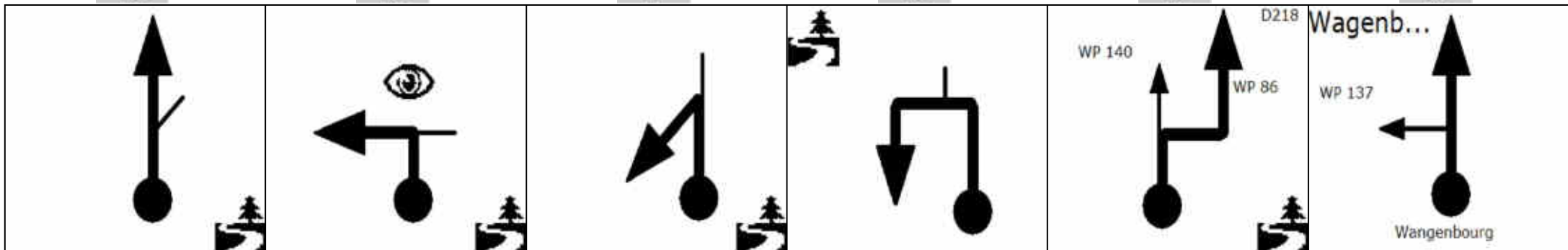





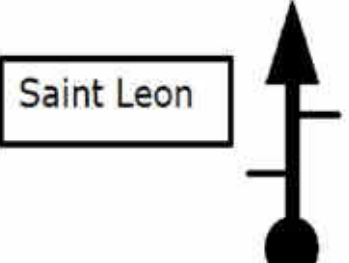
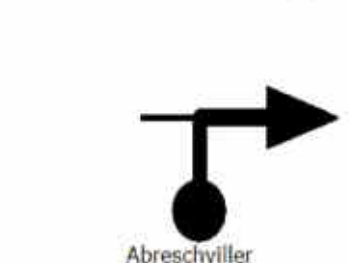
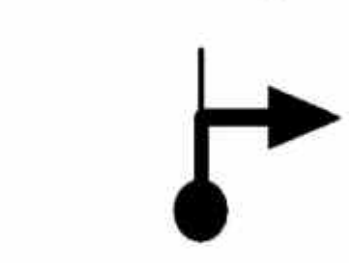
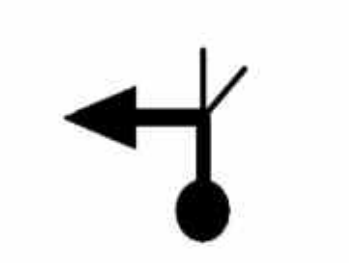





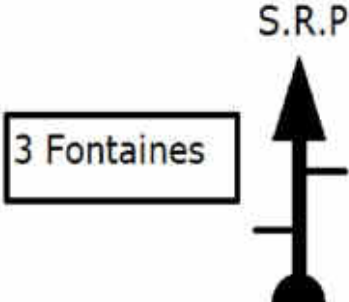
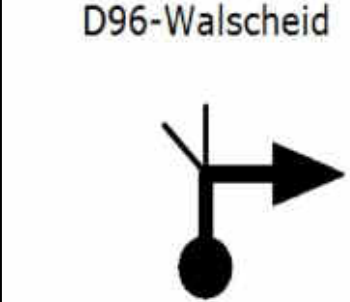



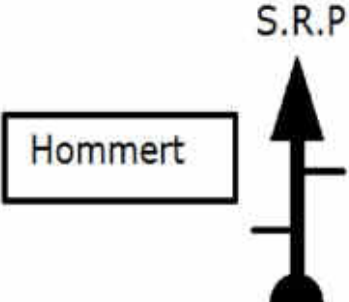





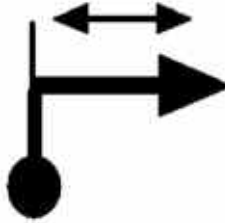

+ 0.8	WP 75	TOT 120.1	+ 0.3	WP 76	TOT 120.4	+ 4.3	WP 77	TOT 124.7	+ 0.1	WP 78	TOT 124.8	+ 1.4	WP 79	TOT 126.2	+ 2.1	WP 80	TOT 128.3
-------	-------	-----------	-------	-------	-----------	-------	-------	-----------	-------	-------	-----------	-------	-------	-----------	-------	-------	-----------



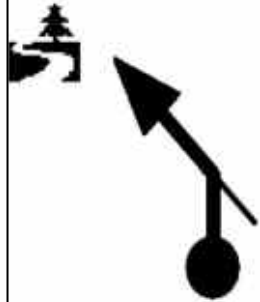

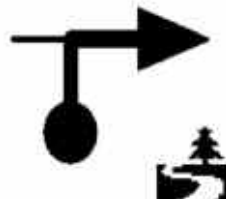

+ 1.1	WP 81	TOT 129.4	+ 1.8	WP 82	TOT 131.2	+ 2.1	WP 83	TOT 133.3	+ 2.0	WP 84	TOT 135.3	+ 0.8	WP 85	TOT 136.1	+ 4.1	WP 86	TOT 140.2
-------	-------	-----------	-------	-------	-----------	-------	-------	-----------	-------	-------	-----------	-------	-------	-----------	-------	-------	-----------

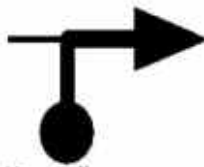
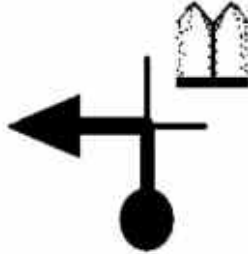
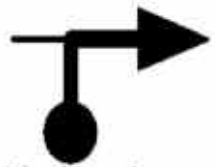

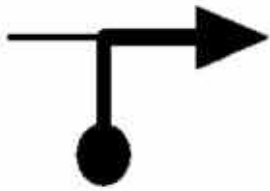
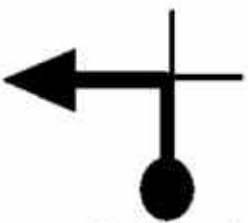

<p>Wagenb...</p>	<p>D224-Windsbourg</p>	<p>Windsbourg</p>			
+ 0.6 WP 87 TOT 140.8	+ 2.0 WP 88 TOT 142.8	+ 6.1 WP 89 TOT 148.9	+ 1.6 WP 90 TOT 150.5	+ 1.5 WP 91 TOT 152.0	+ 3.4 WP 92 TOT 155.4
+ 2.8 WP 93 TOT 158.2	+ 1.2 WP 94 TOT 159.4	+ 1.6 WP 95 TOT 161.0	+ 4.0 WP 96 TOT 165.0	+ 0.7 WP 97 TOT 165.7	+ 2.6 WP 98 TOT 168.3
			<p>WP 107</p>		
+ 0.8 WP 99 TOT 169.1	+ 2.1 WP 100 TOT 171.2	+ 0.8 WP 101 TOT 172.0	+ 1.1 WP 102 TOT 173.1	+ 0.1 WP 103 TOT 173.2	+ 1.8 WP 104 TOT 175.0

<p>Col du Donon</p>  <p>WP 117</p>	<p>S.R.P</p> <p>Saint Leon</p> 	<p>D96-Sarrebourg</p>  <p>Abreschviller</p>	<p>D44c-Vogey</p> 	<p>D44c-La Valette</p> 	
+ 1.6 WP 105 TOT 176.6	+ 1.5 WP 106 TOT 178.1	+ 3.2 WP 107 TOT 181.3	+ 1.9 WP 108 TOT 183.2	+ 0.1 WP 109 TOT 183.3	+ 2.6 WP 110 TOT 185.9
	 <p>Hartzviller</p>	<p>Rue du Moulin</p> 	<p>D96d</p> 	<p>S.R.P</p> <p>3 Fontaines</p> 	<p>D96-Walscheid</p> 
+ 1.5 WP 111 TOT 187.4	+ 1.1 WP 112 TOT 188.5	+ 0.1 WP 113 TOT 188.6	+ 0.7 WP 114 TOT 189.3	+ 2.1 WP 115 TOT 191.4	+ 1.1 WP 116 TOT 192.5
<p>D97c-Hommert</p>  <p>Sitifort</p>	<p>D97-Hommert</p>  <p>Hommert</p>	<p>Hommert</p>  <p>Harreberg</p>	<p>S.R.P</p> <p>Hommert</p> 	<p>D45-Dabo</p> 	<p>D45-Dabo</p> 
+ 0.9 WP 117 TOT 193.4	+ 1.4 WP 118 TOT 194.8	+ 1.1 WP 119 TOT 195.9	+ 1.2 WP 120 TOT 197.1	+ 2.0 WP 121 TOT 199.1	+ 0.9 WP 122 TOT 200.0





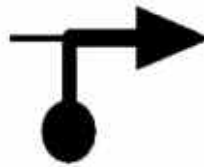
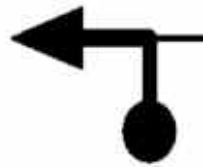

<p>S.R.P</p> <p>Schaeferhof</p>  <p>+ 1.5 WP 123 TOT 201.5</p>	<p>S.R.P</p> <p>Dabo</p>  <p>+ 4.4 WP 124 TOT 205.9</p>	<p>Route de Dabo</p>  <p>+ 1.9 WP 125 TOT 207.8</p>	 <p>+ 1.5 WP 126 TOT 209.3</p>	<p>D45-La Hoube</p>  <p>+ 1.5 WP 127 TOT 210.8</p>	<p>Wasselonne</p>  <p>+ 4.4 WP 128 TOT 215.2</p>
<p>S.R.P</p> <p>Obersteigen</p>  <p>+ 5.3 WP 129 TOT 220.5</p>	<p>D143- Wasselonne</p>  <p>+ 1.0 WP 130 TOT 221.5</p>	 <p>+ 3.8 WP 131 TOT 225.3</p>	 <p>+ 0.9 WP 132 TOT 226.2</p>	<p>D275</p> <p>Allenwiller</p>  <p>+ 0.2 WP 133 TOT 226.4</p>	 <p>+ 0.4 WP 134 TOT 226.8</p>
 <p>+ 0.3 WP 135 TOT 227.1</p>	<p>D229</p> <p>Birkenwald</p>  <p>+ 2.2 WP 136 TOT 229.3</p>	 <p>+ 0.4 WP 137 TOT 229.7</p>	<p>Hengwiller</p>  <p>+ 1.5 WP 138 TOT 231.2</p>	<p>D117</p>  <p>+ 0.2 WP 139 TOT 231.4</p>	<p>D883-Saverne</p> <p>Reinhardsmunster</p>  <p>+ 1.7 WP 140 TOT 233.1</p>

<p>Saverne</p> 	<p>Saverne</p>  <p>Thal-Marmoutier</p>	<p>D218-Saverne</p> 			<p>D421-Metz</p>  <p>Saverne</p>
--	---	--	---	---	---

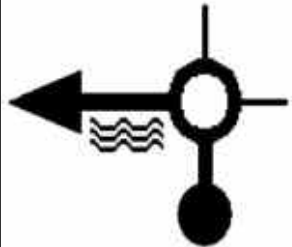
+ 0.7	WP 141	TOT 233.8	+ 4.9	WP 142	TOT 238.7	+ 0.4	WP 143	TOT 239.1	+ 1.2	WP 144	TOT 240.3	+ 0.6	WP 145	TOT 240.9	+ 1.8	WP 146	TOT 242.7
-------	--------	-----------	-------	--------	-----------	-------	--------	-----------	-------	--------	-----------	-------	--------	-----------	-------	--------	-----------

					
---	---	---	---	---	---

+ 0.1	WP 147	TOT 242.8	+ 0.3	WP 148	TOT 243.1	+ 0.0	WP 149	TOT 243.1	+ 0.2	WP 150	TOT 243.3	+ 0.0	WP 151	TOT 243.3	+ 0.3	WP 152	TOT 243.6
-------	--------	-----------	-------	--------	-----------	-------	--------	-----------	-------	--------	-----------	-------	--------	-----------	-------	--------	-----------

<p>D219</p> 			<p>300m</p>  <p>D132</p>	<p>D115-St Jean Sav...</p> 	<p>D115-St Jean Saverne</p> 
--	---	---	---	--	---

+ 0.4	WP 153	TOT 244.0	+ 0.5	WP 154	TOT 244.5	+ 0.1	WP 155	TOT 244.6	+ 0.1	WP 156	TOT 244.7	+ 0.5	WP 157	TOT 245.2	+ 1.3	WP 158	TOT 246.5
-------	--------	-----------	-------	--------	-----------	-------	--------	-----------	-------	--------	-----------	-------	--------	-----------	-------	--------	-----------

